

M40S

SCALE 1:10 R/C 4WD CHASSIS

SCALE 1:10 R/C 4WD CHASSIS instruction manual

ITEM INCLUDED

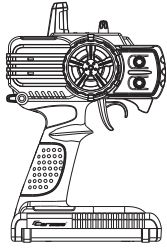

CTX-2710 Transmitter

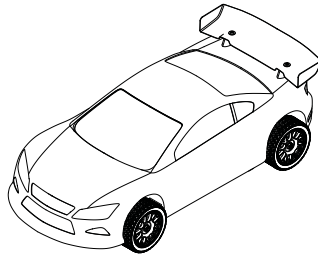

M40S Main Chassis / Car Body / Assembled

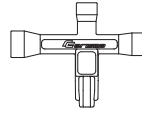

Plastic Wrench



Hex Wrench



Racing Disc

TOOLS REQUIRED

Required Equipment

Recommended to use the following tools to operate or maintenance of your RC model :

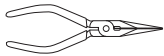

Long Nose Pliers

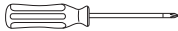

Screwdriver (Small)

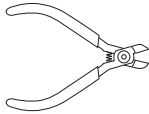

Nippers

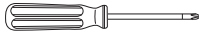

Screwdriver (Large)

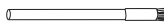

Soft Brush

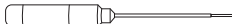

Hex Driver

Instructions for Disposal of WEEE by Users in the European Union

This product must never be thrown away with other waste. Thus the users are liable for disposing the wasted model by submitting them to designated collection stations specific for recycling electronic and electric items. Disposing of the wasted model in this way is helpful to conserve natural resources and enable to keep human health and protect the environment. For more information about wasted model disposal and recycling, please contact your local city office, your disposal service or where you purchased the product.

FOR TRANSMITTER

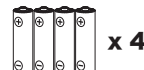

Heavy Duty 1.5V "AA" Size Batteries

ATTENTION

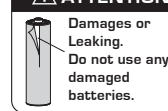

FOR THE CAR

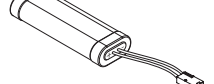

7.2V 1400mAh NiMH Rechargeable Battery Pack

SAFETY PRECAUTIONS

! Safety Precautions

THIS MODEL IS ONLY SUITABLE FOR PEOPLE 14 YEARS OLD AND UP. THIS RADIO CONTROL MODEL IS NOT A TOY.

Beginner should seek advice from experienced person in order to assemble the model or parts correctly and to make best performance.

* Assemble this model or parts only in place out of children's reach, and take safe precautions before operating this model. User is fully responsible for the model assembly and safe operations.

Safety, Precautions, and Warnings

As the user of this product, you are solely responsible for operating it in a manner that does not endanger yourself and others or result in damage to the product or the property of others.

This model is controlled by a radio signal that is subject to interference from many sources outside your control. This interference can cause momentary loss of control so it is necessary to always keep a safe distance in all directions around your model, as this will help to avoid collisions or injury.

- Always operate your model in an open area away from cars, traffic, or people.
- Avoid operating your model on the street where injury or damage can occur.
- Never operate the model out into the street or populated areas for any reason.
- Never operate your model with low transmitter batteries.
- Carefully follow the directions and warnings for this product and any optional support equipments (chargers, rechargeable battery packs, etc.) that you use.
- Keep all chemicals, small parts and anything electrical out of the reach of children.
- Moisture causes damage to electronics. Avoid water exposure to all equipments not specifically designed and protected for this purpose.

Introduction

This is a sophisticated hobby product and not a toy. It must be operated with caution and common sense. User also requires some basic mechanical abilities. Fail to operate this product in a safe and responsible manner could result in injury or do damage to the product or other properties. This product is not intended for use by children without direct adult supervision. The product manual contains instructions for safe operation and maintenance. It is essential to read and follow all the instructions and warnings in the manual prior to assembly, setup or use, in order to operate correctly and avoid damage or injury.

CE Compliance Information For The European Union

The associated regulatory agencies of the following countries recognize the noted certifications for this product as authorized for sale and use.

UK	DE	DK	BG	SE	CZ	ES	NL	SK	HU	RO	FR	PT
FI	EE	LV	LT	PL	AT	CY	SI	GR	MT	IT	IE	LU

FCC ID YDTMTM27HP

Statement - This device complies with Part 15 of the FCC Rules.

Operation is subject to the following two conditions:

- (1) this device may not cause harmful interference, and
- (2) this device must accept any interference received, including interference that may cause undesired operation.

Changes or modifications not expressly approved by the party responsible for compliance could void the user's authority to operate the equipment.

RF Exposure Warning:

This equipment complies with FCC radiation exposure limits set forth for an uncontrolled environment.

And should be operated with minimum distance of 20 cm between the antenna & your body.

Declaration of Conformity

Products: Carisma CTX-2710 2.4GHz Transmitter, MRX2800 Receiver
Equipment Class: 2

The objects of declaration described above are in conformity with the requirements of the specifications listed below.

Item Name : Carisma CTX-2710 2.4GHz Transmitter and MRX2800 Receiver

ETSI EN 300 328 V1.7.1:2006
ETSI EN 301 489-1 V1.8.1:2008
EN 301 489-17 V2.1.1:2009
EN 50371:2002

Directive 1999/5/EC (R&TTE)

Article 3.1a Health

Article 3.1b EMC

Article 3.2 Radio Spectrum



ABOUT THE RADIO SYSTEM

Carisma CTX-2710 2.4GHz FHSS Technology System

The following is an overview of the various functions and adjustments found on CTX-2710 radio system for Carisma models. It is important to read and understand about all of these functions and adjustments before driving.

Power ON / OFF the Transmitter

The Transmitter CTX-2710

- Steering Wheel :** Control direction (Left/ Right) of the RC model.
- Throttle Trigger :** Control speed and direction (Forward/Brake/ Backward)of the driving model.
- Antenna :** Transmit signal to the model.
- Power ON / OFF :** Power ON / OFF the transmitter
- SYNC & Battery Indicator :** Top Green LED light indicates synchronization status and/ or adequate battery power supply.
- Power Indicator :** Bottom Red LED light indicates power "ON".
- Dual Rate Dial :** Adjust the same maximum steering angle on both sides when model turns Left / Right
- ST. Trim Dial :** Adjust the neutral position of steering servo when model wheels are straight ahead.
- TH. Trim Dial :** Make sure the model stays still when releasing the throttle trigger.

Battery Compartment Tray : Cover and hold the batteries powering the transmitter.

* In general, user will experience under steer when making a wide turn at high speed or over steer when making sharp turn at high speed (easy to spin out). User should practice the throttle and steering approach for different cornering at different speed or road surface.

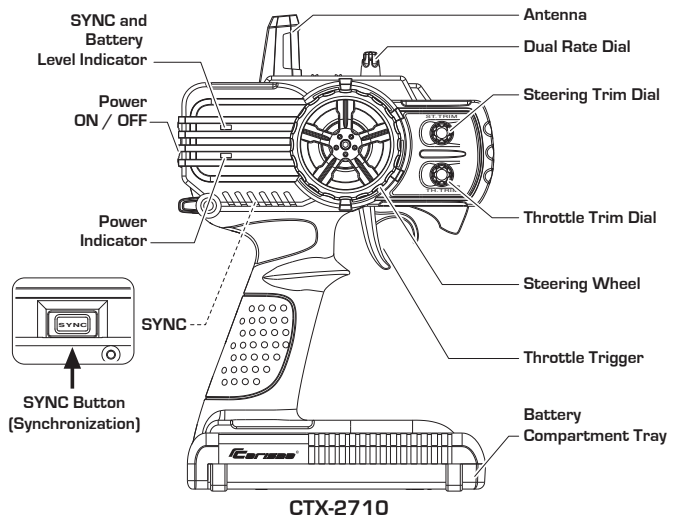

Battery Installation

Supplied with 4 x 1.5V AA Batteries, CTX-2710 can be operated a few hours. Installation: Remove the battery compartment cover as shown below.

Install the batteries observing the polarity marked on battery compartment.

Then reinstall the battery compartment cover as the Picture shown below.

Warning :

Never disassemble batteries or put the batteries in fire, chemical agents, otherwise they may cause personal injuries or property damages.

Battery Disposal :

Observe corresponding regulations about wasted battery treatment regulations.

1. After running out of power, dispose of wasted batteries in designated areas far away from water supply, household areas and planted areas.
2. Submit the wasted batteries to specific recycling stations.

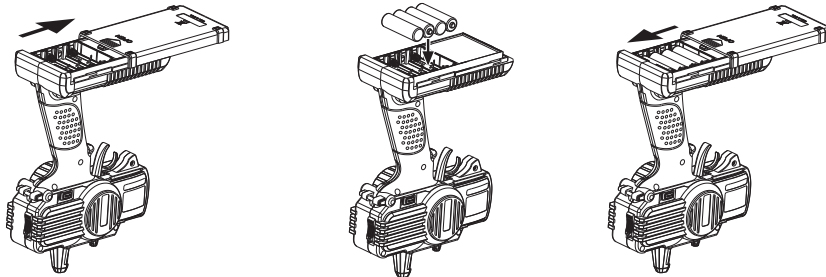

Battery LED Indicator

The Green LED indicator located on the front left side of the transmitter indicates the power supply of batteries. The green LED will go solid on indicating that the batteries have sufficient power. When batteries voltage drops below 4 volts, the Green LED will flash, indicating the batteries power is low and should be replaced.

Solid Green :
Sufficient Power supply

Flashing :
Time to replace batteries

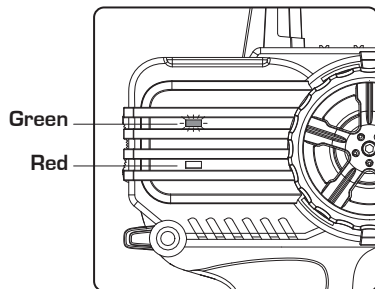

Pre-Run Check

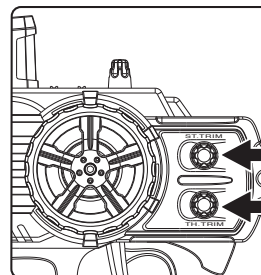

1. Steering : Adjust the steering trim to keep the front wheels in straight line when steering wheel remains in NEUTRAL position.
2. Throttle : Adjust the throttle trim to ensure the rear wheels stop rotating when throttle trigger remains in NEUTRAL position.

* Always turn on the transmitter first by sliding the switch on the left side from bottom to top. The small red and green lights above the switch should both light up. If not, you need to check for low or incorrectly installed batteries.

Top Control Panel

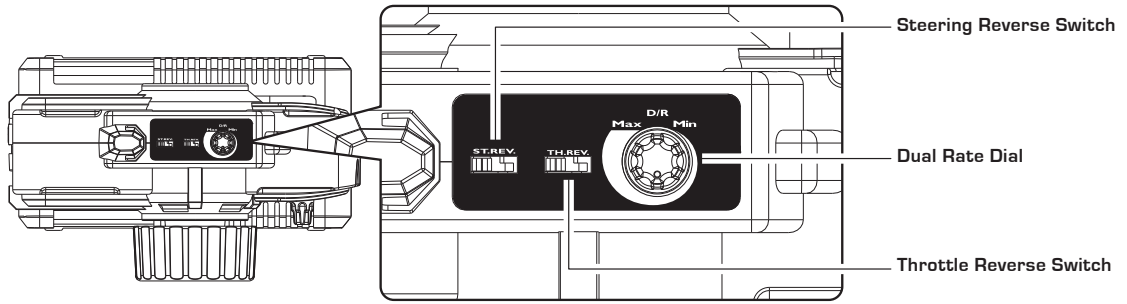

Dual Rate Dial

Dual Rate Dial enables to adjust the same maximum steering angle of servo on both sides (Left and Right) when model makes steering. The Dual Rate Dial affects the sensitivity of servo. Reducing dual rate value can lower the sensitivity of servo and reduce the same maximum steering angle on both sides. Remember to adjust the dual rate value within the adjustment range.

Reversing

Reversing is used to change the response direction of steering wheel and throttle trigger. CTX-2710 Transmitter features 2 reversing functions: Steering Reverse and Throttle Reverse.

Steering Reverse: Reverse the response direction when operating steering wheel. Turning left steering wheel, the model turns right while turning right the model turns left.

Throttle Reverse: Reverse the response direction when operating throttle trigger. Pushing forward throttle trigger the model moves backward while pulling back, the model moves forward. If necessary you can just use a small screwdriver to adjust the corresponding switches.

Trimming

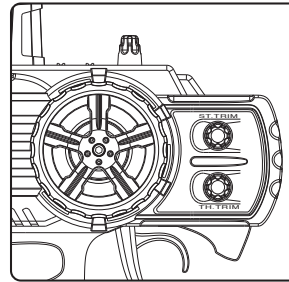

CTX-2710 features two trimming functions:

Steering Trim and Throttle Trim.

Steering Trim Dial :

Adjust the neutral position of steering servo when the wheels are straight ahead. Normally steering trim is adjusted until the model can keep straight tracks.

Throttle Trim Dial :

Adjust neutral position of throttle servo. Make sure the model stays still when releasing the throttle trigger.

RECEIVER CONNECTION AND INSTALLATION

Carisma 2.4GHz Receiver MRX2800

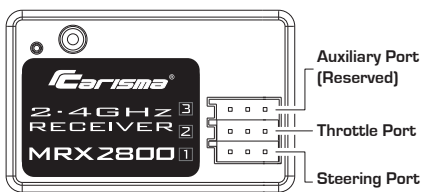

Auxiliary Port (Reserved)

Steering Port : Where to plug in the servos.

Throttle Port : Where to plug in the Electronic Speed Controller (ESC).

Setup button : Synchronize transmitter and receiver. Select frame rate.

Tips :

- Wrap the receiver with something soft, such as foam rubber, to avoid vibration. If there is a chance of getting wet, put the receiver in a waterproof bag or balloon.

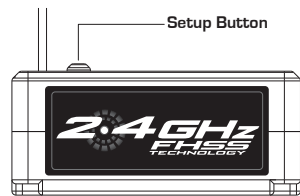

Warning :

- Never bend the metal pins on the PCB of receiver.
- Never cut the antenna cable.
- Install the antenna vertically as shown in the figure.
- Keep the antenna as far away from the motor, ESC and other noise sources as you possibly can.

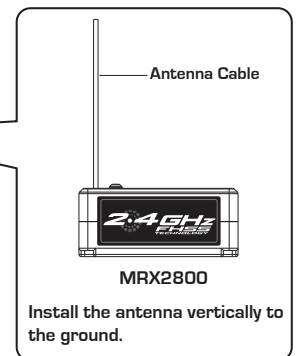

Install the antenna vertically to the ground.

Remarks :

The mounting positions of receiver and antenna cable greatly affect the operating range.

Synchronization & Frame Rate Adjust

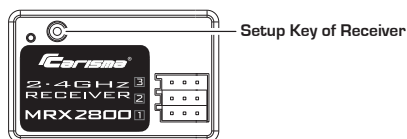

1. Prior to any operation make sure the transmitter and receiver are both turned off.
2. Press and hold the setup button on the receiver while power on the receiver.
3. Release the setup button till green LED flashes.
4. Press the setup button to select the frame rate with green LED flashing.
Faster Flashing = High frame rate (7ms) for digital servo
Slower Flashing = Low frame rate (15ms) for analogue servo
5. Power on the transmitter. With the transmitter steering wheel and throttle trigger in neutral position (full stop and straight steering), press the SYNC button of the transmitter.
6. When synchronization is done, the green LED on both receiver and transmitter will turn solid on.

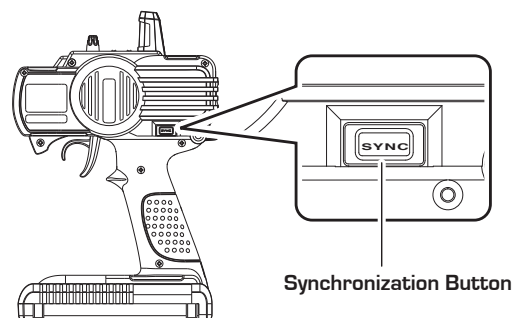

ABOUT THE RADIO SYSTEM

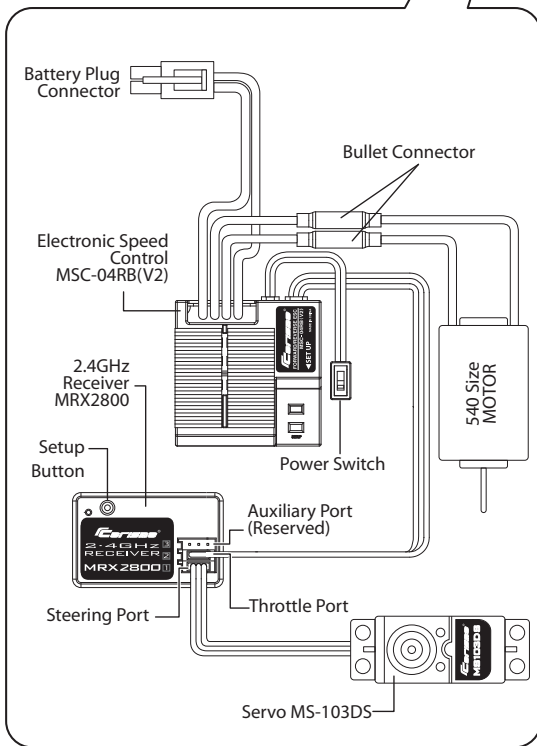
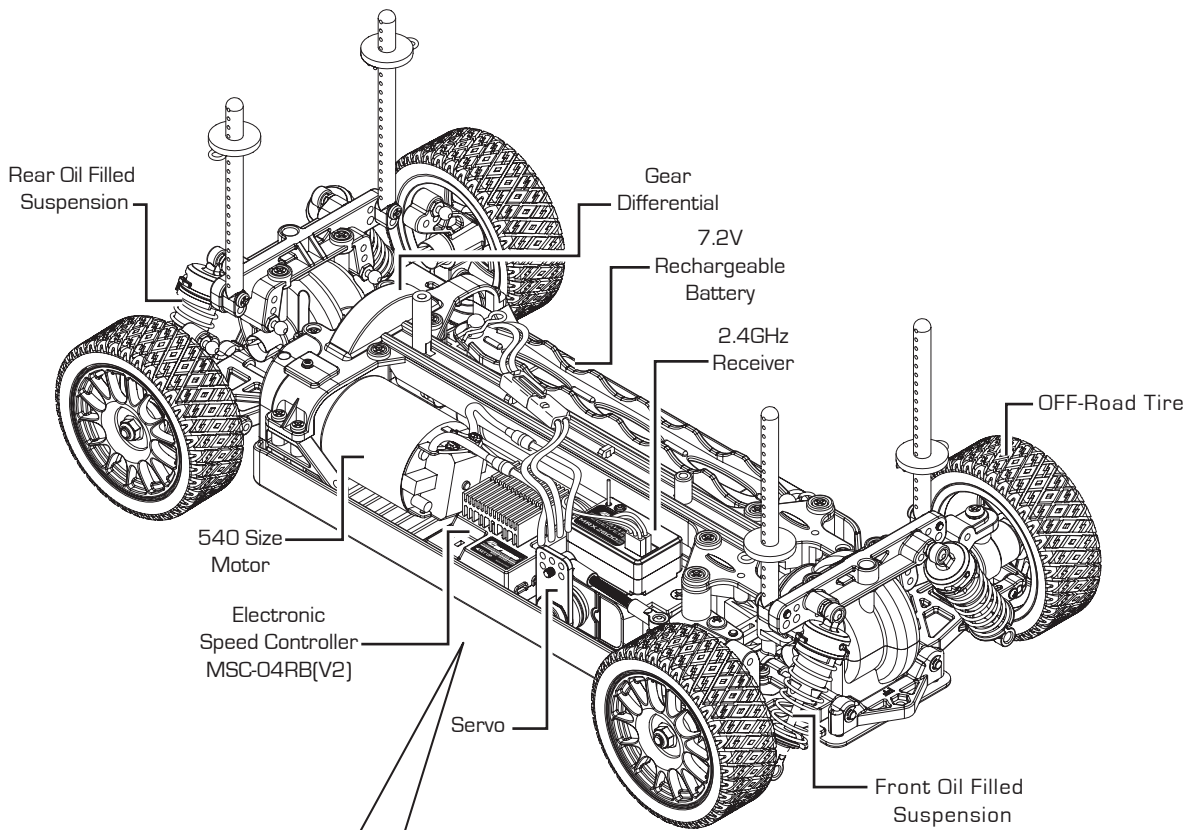

ESC Features

ESC Setup

1. Set TX Throttle Trimmer to neutral position.
2. Connect the battery to ESC (Make sure ESC OFF)
3. Switch on TX
4. Switch on ESC

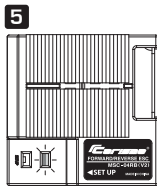

5. Press setup button enter programme mode (Red & Green LED ON)

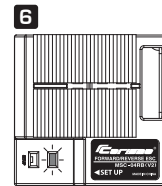

6. Pull Throttle trigger to max forward position and press button to set forward position (Green LED ON)

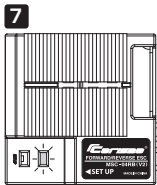

7. Push Throttle trigger to max reverse position and press button to set reverse position (Red LED ON)

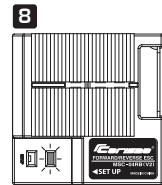

8. Release Throttle trigger to Neutral/ Stop and press button to finish (Green LED ON)

* Each step must be carried out swiftly. Otherwise the program will need to re-set again. The Green LED will be switched on while the trigger is at neutral and the car will not move.

THIS ESC IS DESIGNED FOR THE INCLUDED MOTOR. DO NOT INSTALL ANY OTHER MOTOR CAR IS MOVING WITHOUT PULLING THE TRIGGER. THROTTLE TRIM IS OUT OF POSITION. TRIM THE THROTTLE TRIM.

Battery Pack & Charger Manual

Warning

To reduce the risk of fire, electric shock or injury, carefully follow these instructions.

This manual contains important safety and operating instructions for your charger. Before using the battery charger, read all the following in this instructions manual on the battery chargers and the rechargeable batteries to be charged, and on the products that use the rechargeable batteries.

Plug supplied charger into mains outlet socket. Connect the 7.2V rechargeable battery pack to the charger. The charger's connector fits only one way. Don't force it! If the connectors do not fit together easily, be sure that you have positioned them properly. Average recharging time is approximately 2 to 3 hours maximum. When recharging is over, remove the charger from the household outlet. After recharging is completed, disconnect the battery pack from the battery charger.

The 7.2V battery pack is not supplied pre-charged and you must charge it before connecting the R/C car. The 7.2V battery pack and charger will get hot while charging. This is normal. Do not charge on, or near to, a material / surface that is flammable or can be damaged by heat. When the 7.2V battery pack out of power (dead battery), it should be replaced. Do not dispose in the household garbage but to the collection stations or at a special garbage depot.

Operation

- Completely discharge a Nickel - Metal Hydride (NiMH) battery pack before you charge it. Frequent charging a Nickel - Metal Hydride battery pack that is not fully discharged can shorten its battery life.
- The battery pack cannot be fully charged when it in low temperate environment.
- To charge a very hot after use battery pack can permanently lose its ability to charge.
- Unplug the charger from the mains outlet before attempting any maintenance or cleaning.

Caution

- The battery charger is not a toy.
- Charger only Ni-MH type rechargeable batteries. Other types of batteries may explode and cause serious personally injury or damages.
- Never let the charger or battery pack get wet or damp.
- Overcharging can damage the battery pack. Follow the indicated recharging time.
- Check the batteries regularly for leakage.
- Non-rechargeable batteries are not to be recharged.
- Do not disassemble the charger. Take it to a qualified service technician when service or repair is required. Improper reassembly may result in a risk of fire, electric shock, or injury to persons.
- Do not recharge the battery pack while it is still hot after use. Wait until it has cooled down before recharge.
- Use only the recommended batteries or batteries of equal quality.
- Do not short circuit - all cables should be insulated. If necessary, use vinyl tape for insulation (not included).
- Do not leave battery pack charger unattended when charging.
- The supply terminals are not to be short-circuited.
- Packing has to be kept since it contains important information.
- Do not expose the charger to rain or excessive moisture.
- Do not operate the charger if it has received a sharp blow, or been dropped or damaged in any way. Take it to qualified service technician to repair.
- To reduce the risk of damage to the AC plug and cord, disconnect the charger by pulling plug rather than the cord.
- Do not use an extension cord. It could result in fire or electric shock.
- Do not operate the charge if the cord or plug is damaged. Repair the charger. Never alter the provided AC cord or plug. If does not fit in the AC outlet, have a qualified service technician install the appropriate connector plug. Improper connection can result in an electrical shock. Never use the charger as a DC power source for any other electrical equipments.
- Rechargeable battery pack can explode if under incorrectly or non stop charging.
- Always observe the polarity to correctly connect :
Positive (+) to Positive (+) Negative (-) to Negative (-).

TROUBLE SHOOTING GUIDE

Trouble Shooting Guide / Q&A

Problems	Possible Reasons	Solutions
Short run time / Running slow	<ul style="list-style-type: none"> • Battery not fully charged • Battery power has run down • Motor gets dirty or worn out • Wheel nuts are over tightened • Dust or other objects are inside the gears • Bind drivetrain 	<ul style="list-style-type: none"> • Fully recharge batteries • Replace new batteries • Clean / Replace the damaged part of motor • Slightly loosen the wheel nuts • Clean the gears • Full check all drive trainparts
Don't Run straight	<ul style="list-style-type: none"> • Steering trim is not adjusted correctly 	<ul style="list-style-type: none"> • Adjust the steering trim on the transmitter.
Model doesn't stop when throttle trigger stay at " Neutral " position	<ul style="list-style-type: none"> • Throttle trim is not adjusted correctly 	<ul style="list-style-type: none"> • Adjust the throttle trim on the transmitter
Model doesn't operate	<ul style="list-style-type: none"> • Transmitter batteries have run down • Transmitter not switched on • ESC / Receiver not switched on • Battery power has run down • Poor synchronization of transmitter and receiver 	Replace new AA alkaline batteries Turn on the transmitter Switch on the ESC / Receiver Replace new batteries Resynchronize transmitter and receiver
Reversed transmitter steering direction	Improper setting of throttle reverse switch	Check steering reverse switch on top panel and set to the opposite side.
Reversed transmitter throttle direction	Improper setting of steering reverse switch	Check throttle reverse switch on top panel and set to the opposite side.
Poor operating range	<ul style="list-style-type: none"> • Transmitter battery low • Transmitter antenna not pointing upward • Battery power has run down • Receiver antenna Cut / Worn 	<ul style="list-style-type: none"> • Check / Replace new AA batteries • Let antenna pointing upward • Charge up the battery and retry • Check if properly attaching or repair if necessary
Lose Control	<ul style="list-style-type: none"> • Batteries have run down • Receiver antenna Cut / Worn 	<ul style="list-style-type: none"> • Check / Replace new batteries • Check Receiver Antenna
Steering doesn't work	<ul style="list-style-type: none"> • Servo gears damaged • Servo Saver Broken 	<ul style="list-style-type: none"> • Replace a new servo • Replace new servo saver
Q: Why does the analog servo fail to work properly with the CTX-2710		A: High frame rate setting results in the abnormal performance of analog servo. For analog servo, please choose low frame rate (15ms). [See P.3 for How to Select Frame Rate]
Q: What is the difference between high frame rate and low frame rate while using digital servo?		A: High frame rate setting enables shorter response time. It is suggested to use high frame rate for digital servo.



Manufactured by :

MUN AH PLASTIC ELECTRONIC TOYS CO., LTD.

21/Floor, Kingsway Industrial Building, Phase 2,

173 - 175 Wo Yi Hop Road, Kwai Chung, N.T., Hong Kong

Tel : (852) 2427 5831 Fax : (852) 2480 3087 Email : info@matoys.com

Visit Us on www.carisma.com.hk

© 2012 Carisma. All Rights Reserved. Product specifications are subject to change.
Some models shown are prototypes which may vary slightly from what is inside.



Printed in China
MAN-G00307

